

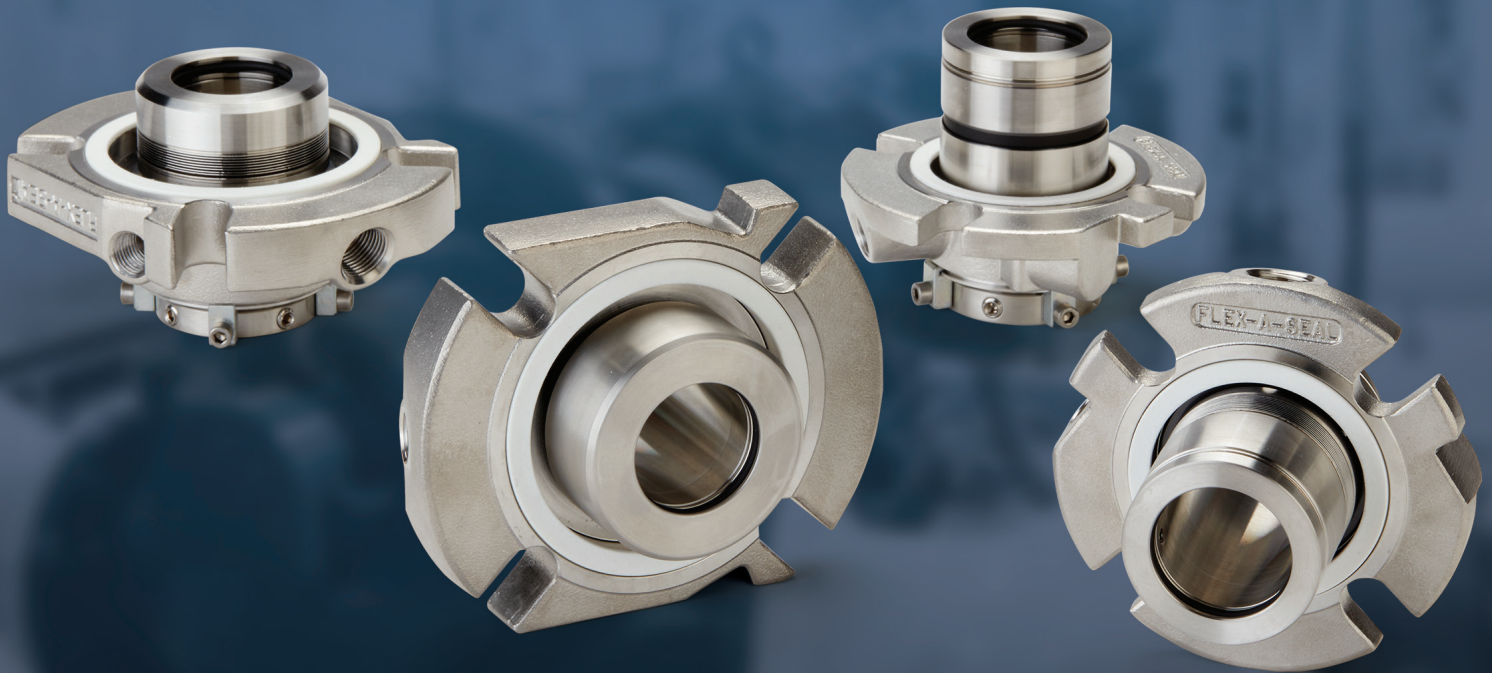

# ANSI FLEX SEAL LINE

The Versatile Standardized Solution for ANSI Pumps



Conventional pump stuffing boxes were originally designed to accommodate packing materials. Over the years mechanical seals edged out packing as a preferred sealing method; however stuffing boxes essentially remained the same. This situation posed complications for the effective operation of mechanical seals including installation issues, potential damage from abrasive product, and poor dispersion of seal-generated heat.

The ANSI Standard ASME B73.1 Specifications for Horizontal End Suction Centrifugal Pumps for Chemical Process includes requirements to improve the reliability and safety of the B73.1 pump design. One major specification focuses on cylindrical (big bore) and self-venting (tapered bore) seal chambers to address issues which plague standard bore seal chambers. The enlarged chambers provide additional radial clearance for mechanical seal operation and for increased liquid circulation around the seal, enabling the seal to run cooler and longer.

## THE ANSI FLEX DIFFERENCE

- Big Bore faces are designed with larger ODs for additional radial clearance and seal cooling
- Both standard and big bore glands supplied with 3 connections to accommodate any piping plan
- Set clip redesign for even easier seal installation

# ANSI FLEX ARB3 (STANDARD) & ABRB3 (BIG BORE)

## Materials of Construction

Rotating Seal Face	Carbon, Tungsten carbide, Sintered silicon carbide
Stationary Seal Face	Sintered silicon carbide
Bellows	Hastelloy® C276
Metallurgy	316 SS
Elastomers	Viton®, Ethylene propylene, Aflas®, Buna, Neoprene, Perfluorelastomer
Gland Gasket	Glass-filled Teflon™
Throttle Bushing	Glass-filled Teflon™

## Operating Parameters

Temperature	400° F (200°C)
Pressure	300 PSI (20 Bar)
Speed	4500 FPM

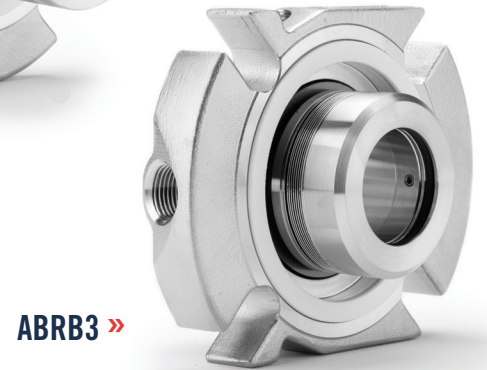
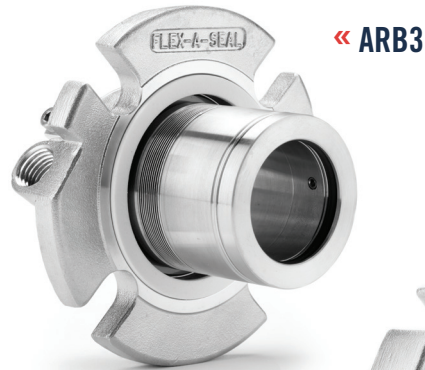

# ANSI FLEX ASMS3 (STANDARD) & ABSMS3 (BIG BORE)

## Materials of Construction

Rotating Seal Face	Sintered silicon carbide
Stationary Seal Face	Carbon, Sintered silicon carbide
Springs	Hastelloy® C276
Metallurgy	316 SS
Elastomers	Viton®, Ethylene propylene, Aflas®, Buna, Neoprene, Perfluorelastomer
Gland Gasket	Glass-filled Teflon™
Throttle Bushing	Glass-filled Teflon™

## Operating Parameters

Temperature	400° F (200°C)
Pressure	300 PSI (20 Bar)
Speed	6000 FPM

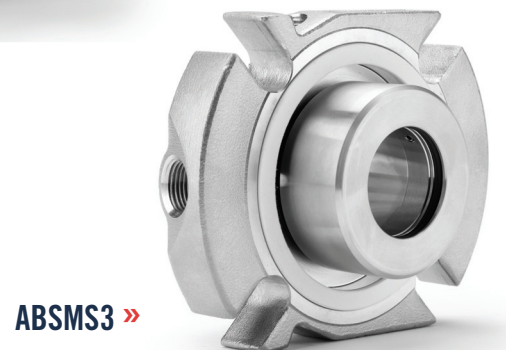
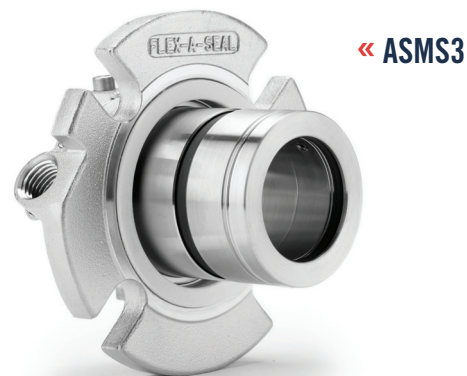

\* Maximum temperature/speed/pressure/runout indicates operating extremes independently and does not imply the seal will function at these extremes at the same time.

### Registered Trademarks:

Viton® - Dupont Performance Elastomers; Aflas® - Asahi Glass Co.; Teflon® - E.I. Dupont de Nemours and Co; Hastelloy® - Haynes International, Inc.

# ANSI FLEX LINE FEATURES

- Simple cartridge seal installation
- Sleeve is isolated from process fluid
- 3/8 NPT flush connection allows for cooling and venting of seal.
- 1/4 NPT vent and drain connections provide differential sizing to minimize the potential of improper piping
- Non-sparking throttle bushing is positively retained to avoid pressure blow out, minimizing leakage in the event of seal failure.
- ANSI Flex glands include flush, vent, and drain connections and a close-clearance, non-sparking throttle bushing to direct any leakage to the drain connection.
- Angled gland connections allow for easier pipe fitting.
- Setting clips provide positive axial and radial setting of the ANSI Flex cartridge seal to insure proper seal installation. The ANSI Flex clips are easy to access for simple removal.
- Only one Allen wrench required to tighten screws and remove the setting clips.

---

## INDIVIDUAL STYLE FEATURES

### ASMS3/ABSMS3

- Stationary springs and drive pin mechanism isolated from process fluids to minimize corrosion, clogging, and stress-related failures
- Unique, metal-shrouded rotary seal ring for maximum face protection and uniform 360° transfer of torque to the rotating face during start up.
- Dynamic elastomer moves on non-metallic, smooth surface eliminating fretting
- Stationary design for optimal face alignment

### ARB3/ABRB3

- Rotating design uses centrifugal force for self-cleaning
- Uniform 360° transfer of torque to the rotating face
- Welded metal bellows replace the dynamic elastomer which can hang up the seal faces
- No springs to clog or break
- No fretting
- Only two (2) static elastomers – eliminate seal failures caused by dynamic O-ring “hang up” and offers cost savings when upgrading to Perfluorelastomers.

## INDIVIDUAL BIG BORE FEATURES

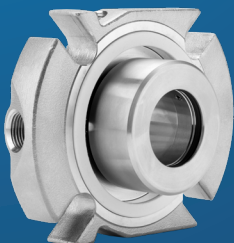

### ABSMS3

Monolithic rotating seal ring made from a solid, homogenous material and is easily field-repairable.

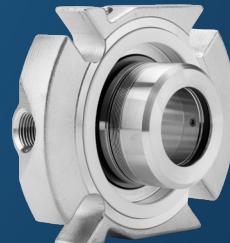

### ABRB3

Floating stationary seat design adjusts for misalignment and is cushioned from vibration, both of which improve face tracking.

## DIMENSIONAL CHART – ASMS3 & ARB3 STANDARD BORE SEALS

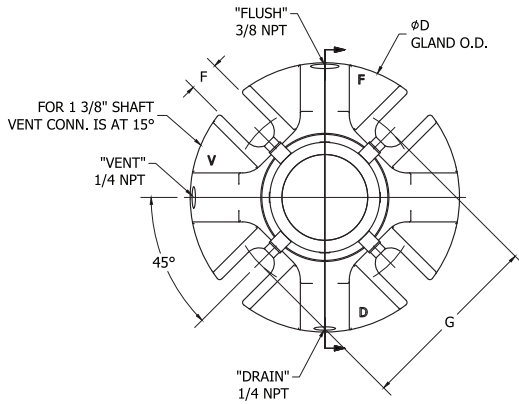
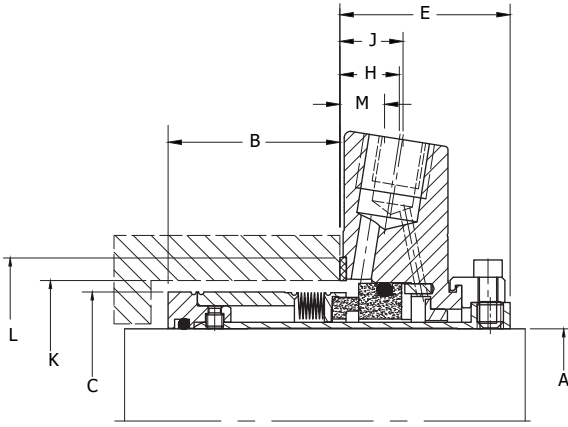

A	B	C	D	E	F
SHAFT DIAMETER	INBOARD LENGTH	INBOARD O.D. ASMS3 & ARB3	GLAND O.D.	OUTBOARD LENGTH	SLOT WIDTH
1.375	1.600	1.950	4.250	1.625	0.525
1.750	1.630	2.450	5.500	1.615	0.625
1.875	1.630	2.575	5.500	1.615	0.563
2.125	1.585	2.825	6.000	1.805	0.688
2.500	1.650	3.320	6.500	1.805	0.750
2.625	1.650	3.560	6.500	1.805	0.688

A	G	H	J	K	L	M
SHAFT DIAMETER	BOLT CIRCLE	FLUSH LOCATION	VENT/DRAIN LOCATION	GASKET I.D.	GASKET O.D.	GLAND LENGTH AT STUDS
1.375	3.250	0.605	0.675	2.165	2.605	0.425
1.750	3.800	0.562	0.562	2.665	3.105	0.625
1.875	3.875	0.562	0.670	2.790	3.230	0.625
2.125	4.375	0.562	0.650	3.165	3.605	0.625
2.500	4.700	0.562	0.650	3.500	3.855	0.625
2.625	4.875	0.562	0.650	3.625	4.070	0.625

## DIMENSIONAL CHART – ABSMS3 & ABRB3 BIG BORE SEALS

A	B	C		D	E	F
		ASMS3	ARB3			
SHAFT DIAMETER	INBOARD LENGTH	INBOARD O.D. ASMS3	INBOARD O.D. ARB3	GLAND O.D.	OUTBOARD LENGTH	SLOT WIDTH
1.375	0.847	2.407	2.187	5.250	2.000	0.500
1.750	0.915	2.782	2.562	6.500	2.000	0.625
1.875	0.945	2.907	2.687	5.875	1.970	0.625
2.125	0.955	3.157	2.937	7.250	1.970	0.750
2.500	1.093	3.687	3.437	8.000	1.970	0.750
2.625	1.030	3.813	3.625	7.000	2.000	0.625

A	G	H	J	K	L	M
SHAFT DIAMETER	BOLT CIRCLE	FLUSH LOCATION	VENT/DRAIN LOCATION	GASKET I.D.	GASKET O.D.	GLAND LENGTH AT STUDS
1.375	4.000	0.605	0.750	2.875	3.375	0.815
1.750	4.750	0.800	0.812	3.570	4.070	0.775
1.875	4.800	0.800	0.812	3.570	4.070	0.712
2.125	5.750	0.800	0.812	3.875	4.610	0.712
2.500	6.375	0.800	0.812	4.700	5.325	0.712
2.625	6.000	0.800	0.812	4.625	5.125	0.775



[www.flexaseal.com](http://www.flexaseal.com) / [sales@flexaseal.com](mailto:sales@flexaseal.com)

### VERMONT HEADQUARTERS

291 Hurricane Ln.  
Williston, VT 05495  
TEL 1-800-426-3594 (USA Only)  
or 1-802-878-8307  
FAX 1-802-878-2479

### GULF COAST

1719 S. Sonny Ave.  
Gonzales, LA 70737  
TEL 1-225-484-0007  
FAX 1-225-341-8922

### TEXAS

7545 E. Orem Dr.  
Houston, TX 77075  
TEL 1-832-804-7424

### BRAZIL

Rua Javaes, 441/443  
Bom Retiro, Sao Paulo  
Brazil CEP 01130-010  
TEL 55-11-3736-7373  
or 55-11-3736-7371  
FAX 55-11-3736-7355

### DISTRIBUTED BY